

SEC' : B-B''

- NOTES
1. MATERIAL : PHOSPHOR BRONZE
0.3mm THICKNESS
 2. FINISH : PRE-PLATED TIN
 3. RECOMMENDED LENGTH OF WIRE STRIP IS 4.0-4.8mm.

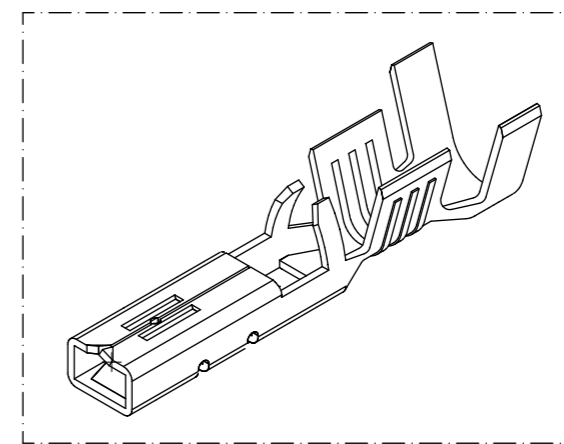

ISOMETRIC VIEW

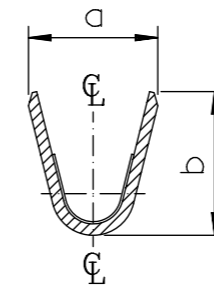
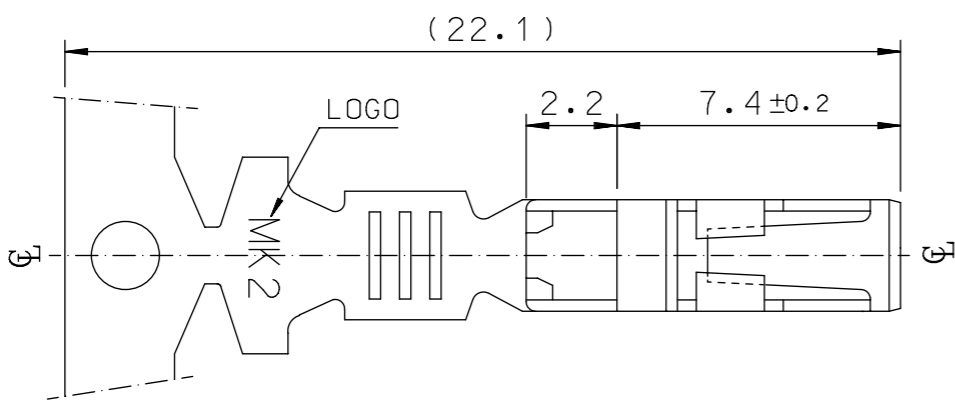
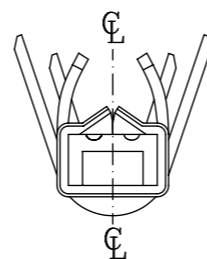
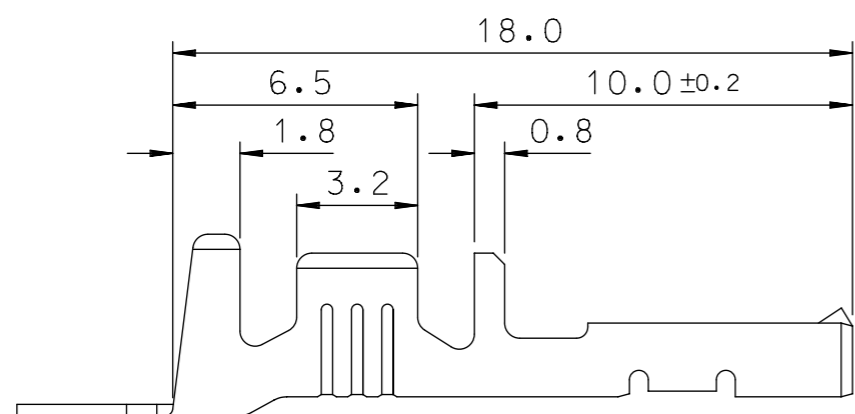

SEC' : C-C''

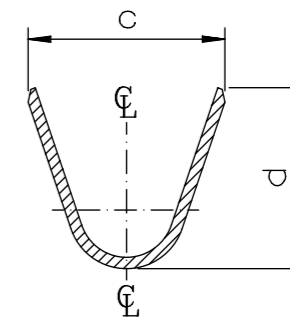

SEC' : D-D''

MATERIAL NO	ENG. No.	AWG	a	b	c	d	P
357480210	35748-0210	#18-#14	3.4	3.8	5.2	4.8	12.0
357480110	35748-0110	#22-#20	2.85	2.8	4.2	4.0	10.6
357480410	35748-0410	#24	2.2	1.75	3.85	3.5	10.6

SYMBOLS DIMENSION UNITS: mm SCALE: 5:1 GENERAL TOLERANCES (UNLESS SPECIFIED): ANGULAR TOL: ± 1.0° 4 PLACES: ± 3 PLACES: ± 2 PLACES: ± 0.3 1 PLACE: ± 0.3 0 PLACES: ± DRAFT WHERE APPLICABLE MUST REMAIN WITHIN DIMENSIONS	THIS DRAWING CONTAINS INFORMATION THAT IS PROPRIETARY TO MOLEX ELECTRONIC TECHNOLOGIES, LLC AND SHOULD NOT BE USED WITHOUT WRITTEN PERMISSION		CURRENT REV DESC: EC NO: 605910 DRWN: JSSHIN 2018/10/11 CHK'D: SHCHU 2018/10/15 APPR: YSKIM02 2018/10/16			
	PRODUCT CUSTOMER DRAWING		INITIAL REVISION: DRWN: BKCHOI 1992/11/17 APPR: CWLEE 1992/11/17			
DOCUMENT NUMBER: SD-35748-001 DOC TYPE: PSD DOC PART: 001 REVISION: F2	MATERIAL NUMBER: SEE TABLE CUSTOMER: GENERAL MARKET		SHEET NUMBER: 1 OF 1		THIRD ANGLE PROJECTION:	
DRAWING: A3-SIZE SERIES: 35748	SEE TABLE		GENERAL MARKET		1 OF 1	

DOCUMENT STATUS	RELEASE DATE
-----------------	--------------

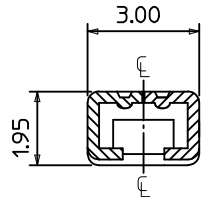
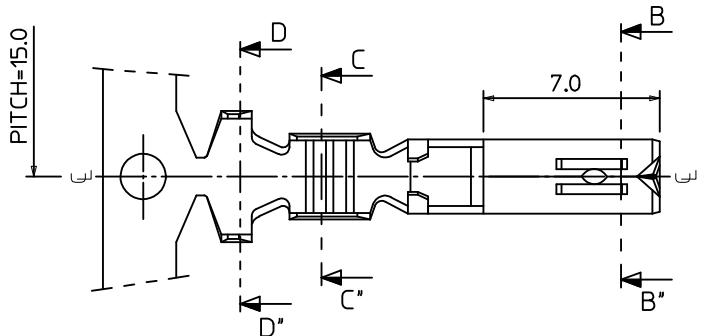

SEC' : B-B'

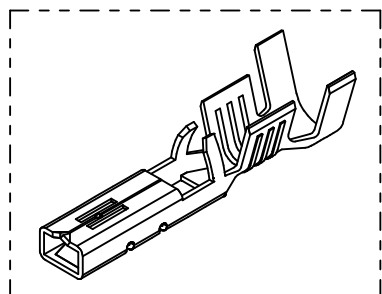
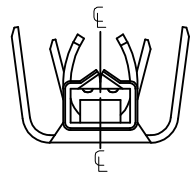
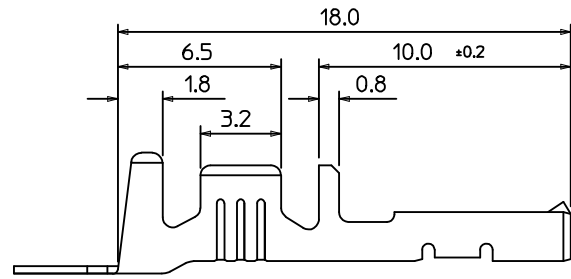

ISOMETRIC VIEW

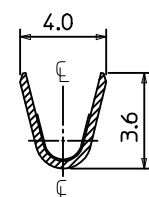
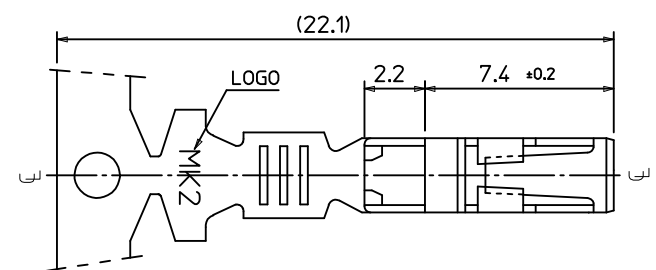

SEC' : C-C'

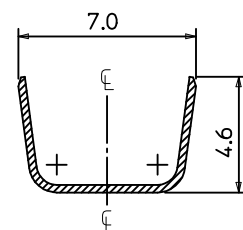

SEC' : D-D'

NOTES

1. MATERIAL : PHOSPHOR BRONZE
0.3mm THICKNESS
2. FINISH : PRE-PLATED TIN
3. RECOMMENDED LENGTH OF WIRE STRIP IS 4.0-4.8mm.
- ④ 4. APPLICABLE WIRE SIZE : AWG #20+#20
AWG #20+#18
AWG #18+#18

REVISED EC NO: KOR2016-0060 DRWN: JSSHIN 2015/12/24 CHKD: SHCHU 2015/12/28 APPR: YSK1M02 2015/12/30	DESCRIPTION 1	QUALITY SYMBOLS	GENERAL TOLERANCES (UNLESS SPECIFIED)	DIMENSION STYLE	SCALE	DESIGN UNITS	THIRD ANGLE PROJECTION															
		$\nabla = 0$ $\sphericalangle = 0$	<table border="1"> <tr> <th></th> <th>mm</th> <th>INCH</th> </tr> <tr> <td>4 PLACES</td> <td>± ---</td> <td>± ---</td> </tr> <tr> <td>3 PLACES</td> <td>± ---</td> <td>± ---</td> </tr> <tr> <td>2 PLACES</td> <td>± 0.3</td> <td>± ---</td> </tr> <tr> <td>1 PLACE</td> <td>± 0.3</td> <td>± ---</td> </tr> </table>		mm	INCH	4 PLACES	± ---	± ---	3 PLACES	± ---	± ---	2 PLACES	± 0.3	± ---	1 PLACE	± 0.3	± ---	MM ONLY	5:1	METRIC	
			mm	INCH																		
		4 PLACES	± ---	± ---																		
3 PLACES	± ---	± ---																				
2 PLACES	± 0.3	± ---																				
1 PLACE	± 0.3	± ---																				
<table border="1"> <tr> <td>DRAWN BY</td> <td>DATE</td> <td>TITLE</td> </tr> <tr> <td>BKCH01</td> <td>1992/11/17</td> <td rowspan="2">.070 FEMALE TERMINAL (B-TYPE)</td> </tr> <tr> <td>CHECKED BY</td> <td>DATE</td> </tr> <tr> <td>BKCH01</td> <td>1992/11/17</td> <td></td> </tr> <tr> <td>APPROVED BY</td> <td>DATE</td> <td></td> </tr> <tr> <td>YSK1M02</td> <td>2015/12/30</td> <td></td> </tr> </table>	DRAWN BY	DATE	TITLE	BKCH01	1992/11/17	.070 FEMALE TERMINAL (B-TYPE)	CHECKED BY	DATE	BKCH01	1992/11/17		APPROVED BY	DATE		YSK1M02	2015/12/30		MATERIAL NO. 357480310		DOCUMENT NO. SD-35748-003	SHEET NO. 1 OF 1	
DRAWN BY	DATE	TITLE																				
BKCH01	1992/11/17	.070 FEMALE TERMINAL (B-TYPE)																				
CHECKED BY	DATE																					
BKCH01	1992/11/17																					
APPROVED BY	DATE																					
YSK1M02	2015/12/30																					
DRAFT WHERE APPLICABLE MUST REMAIN WITHIN DIMENSIONS		THIS DRAWING CONTAINS INFORMATION THAT IS PROPRIETARY TO MOLEX INCORPORATED AND SHOULD NOT BE USED WITHOUT WRITTEN PERMISSION																				